

3D Visualization of Optical Systems

Abstract

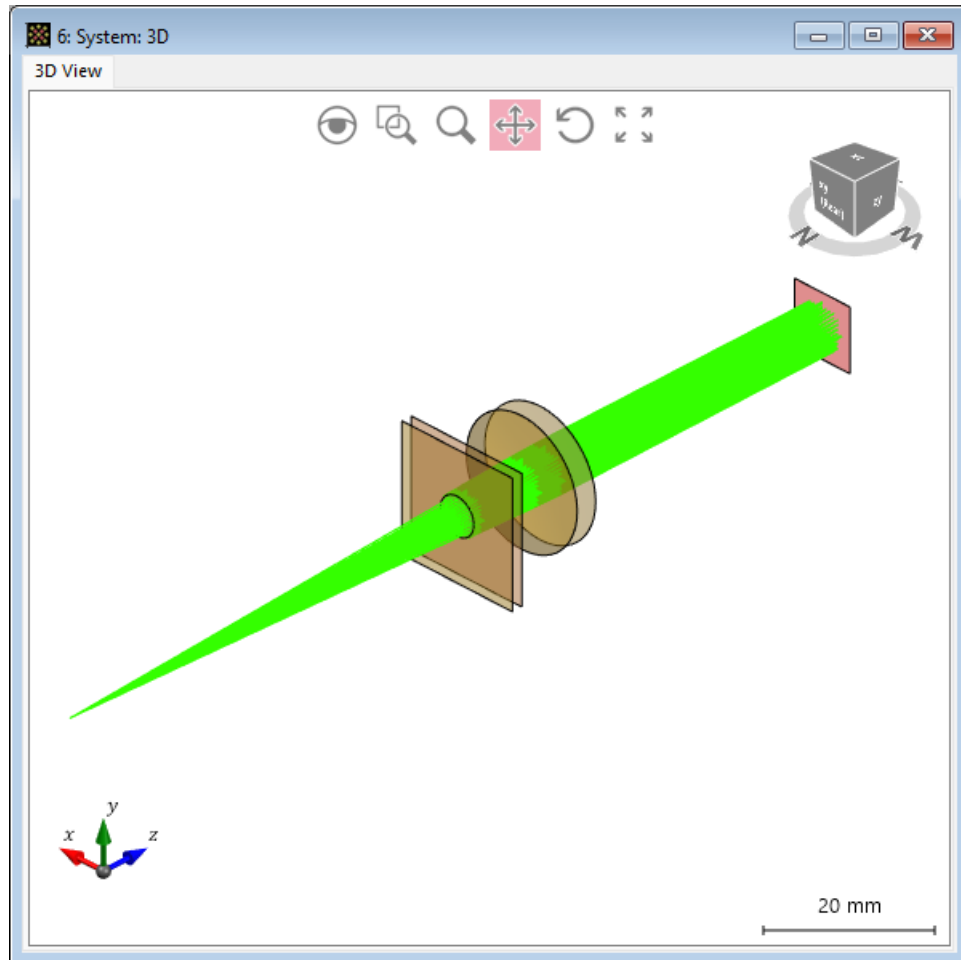

For a fundamental understanding of the properties of an optical system, a visualization of its components together with an indication of the light propagation is immensely helpful. For this purpose, VirtualLab Fusion provides tools which display a three-dimensional visualization of optical systems. These tools can further be used to check the positioning of elements and detectors, as well as to get a quick overview of the light propagation inside the system. The applied modeling technique for the 3D-view is comparable to classic ray tracing.

How to Generate a System View Document

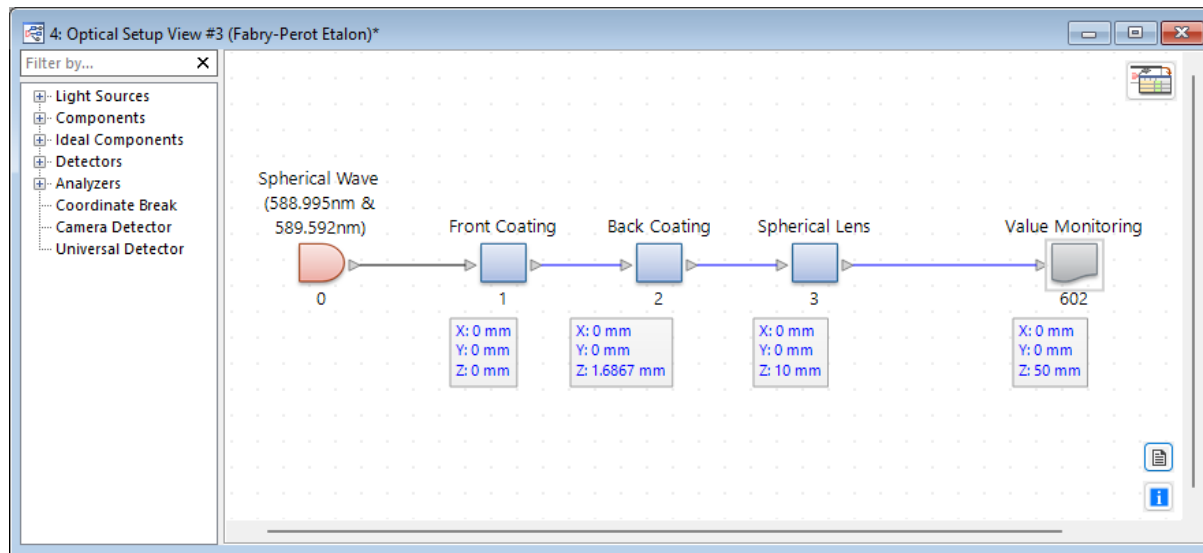
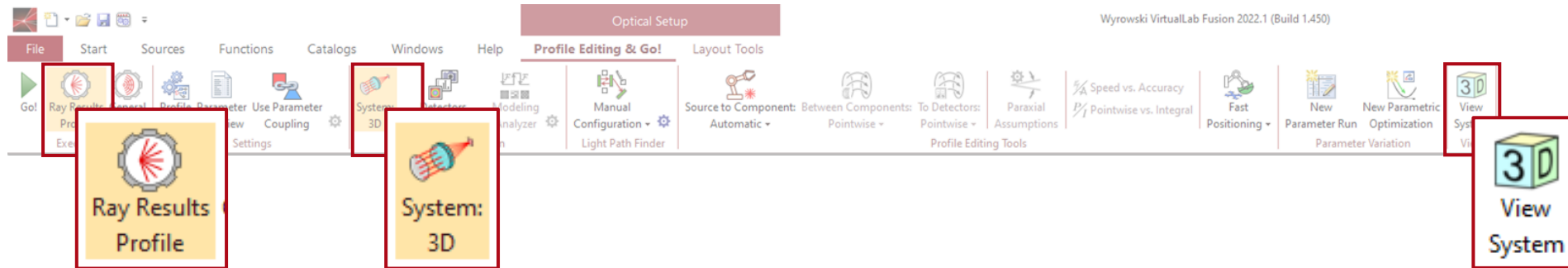

3D-views of an optical system can be generated in two different ways:

1. Use *Ray Results Profile* and choose *System: 3D* as result, then run the simulation.
2. Click on *View System* (just 3D-display of the components, no light propagation).

System: 3D (Ray Result Profile) vs. 3D System View

The major difference between the two methods is that the first also provides information about the propagating light by using the *Ray Results Profile*, while in the latter only components and detectors will be displayed.

We will focus on the *System 3D* view for the rest of the Use Case.

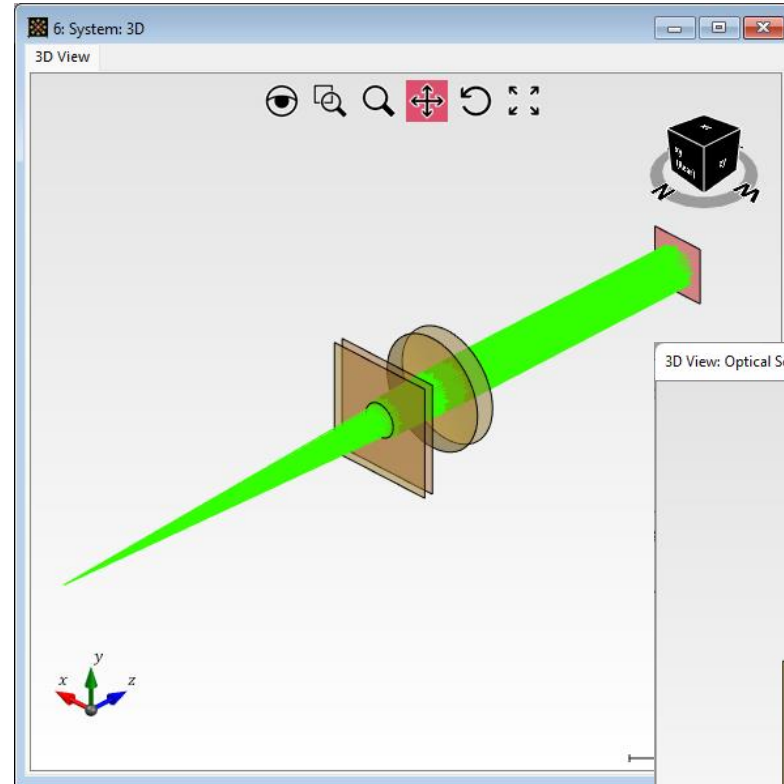

System: 3D view for Ray Results Profile

3D System View:
system visualization without
depiction of light

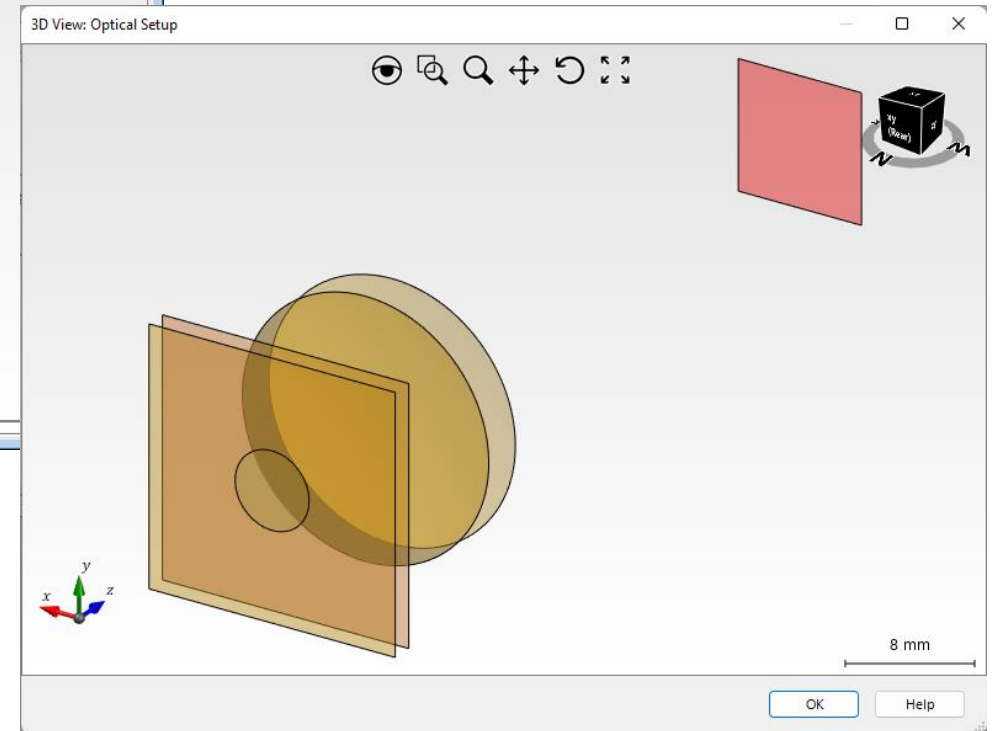

Options – Select Elements to Show

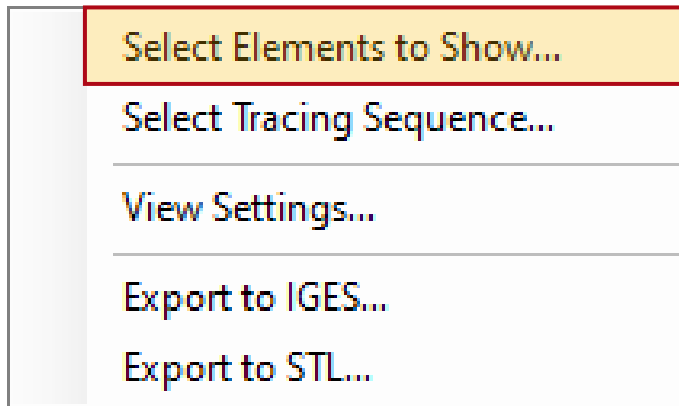

A menu providing detailed options is available by right-clicking on the document window. The first option “*Select Elements to Show*” allows the configuration of the elements of the system which are shown in the document (by default all elements are shown).

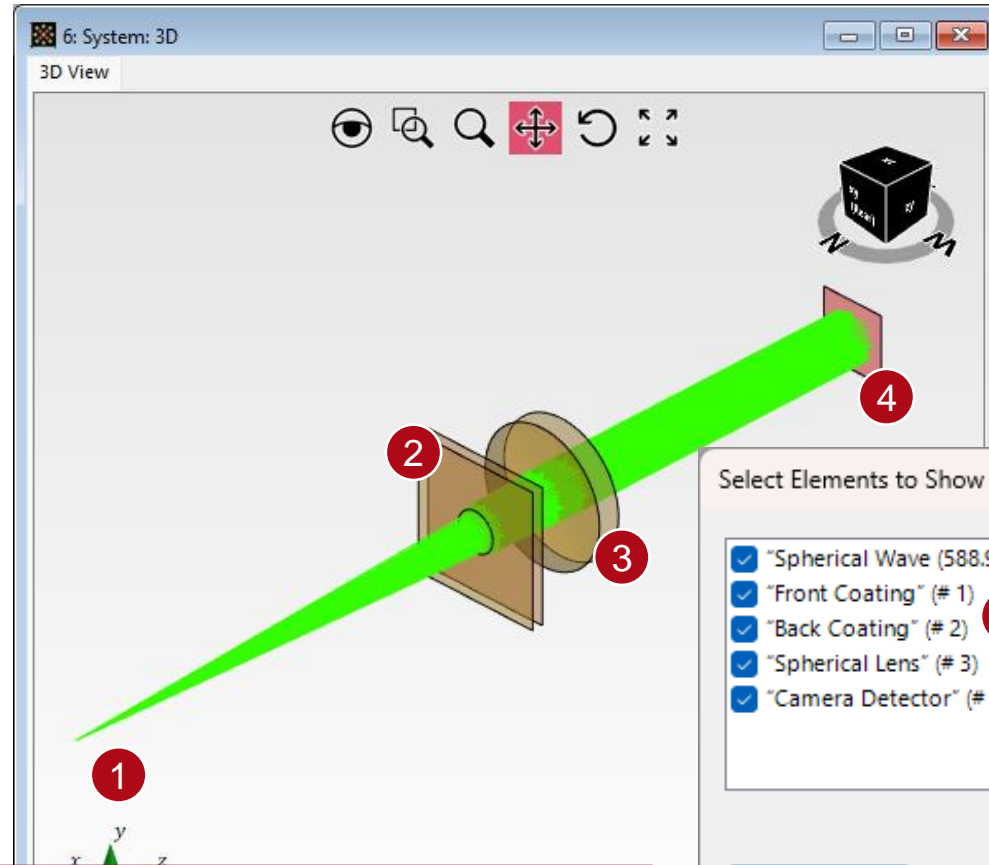

Fabry-Perot Etalon

See full use case:
[Examination of Sodium D Lines with Etalon](#)

If the system has many elements, *Selection Tools* can be useful to ease the workload.

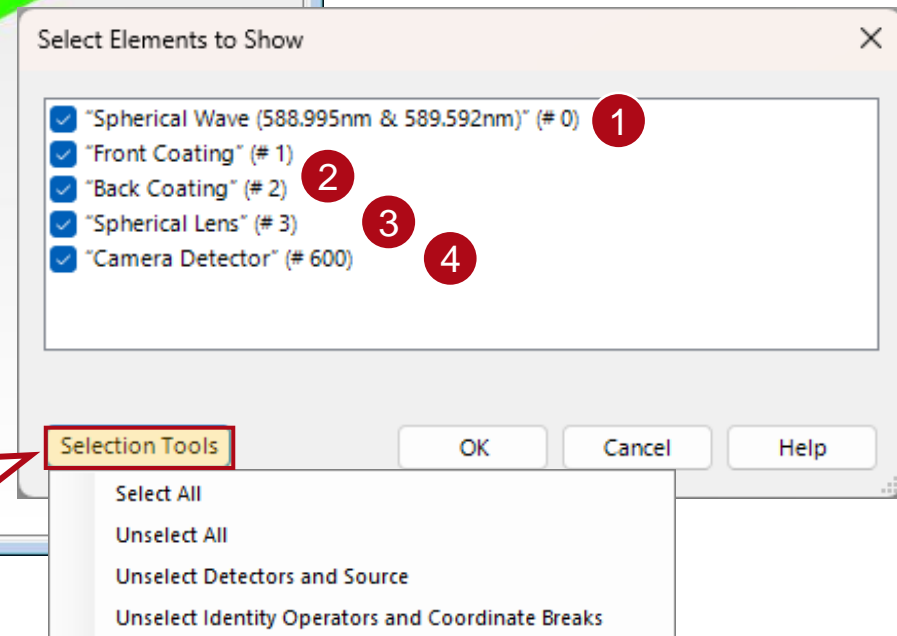

Options – Select Tracing Sequence

Herriott Cell - See full use case: [Modeling of a Herriott Cell](#)

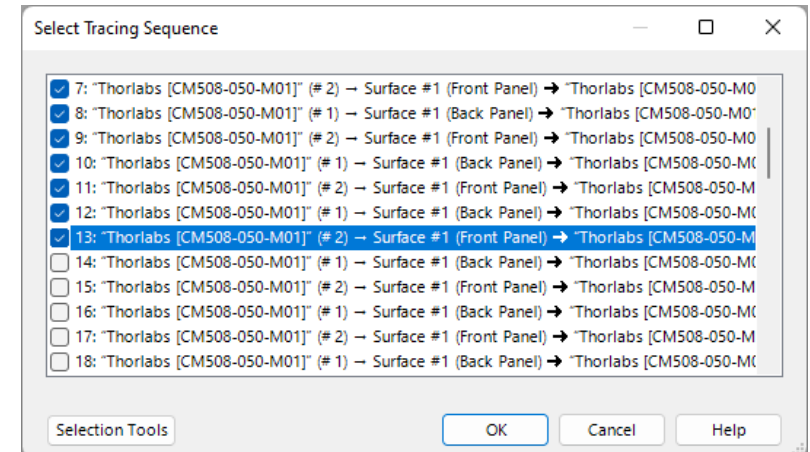
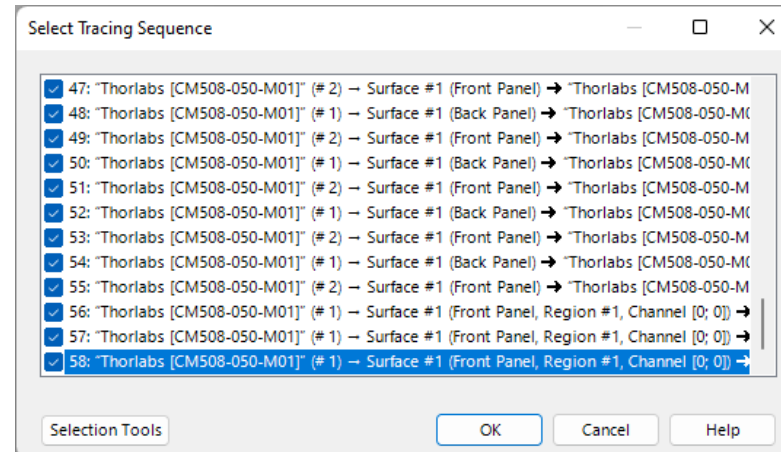
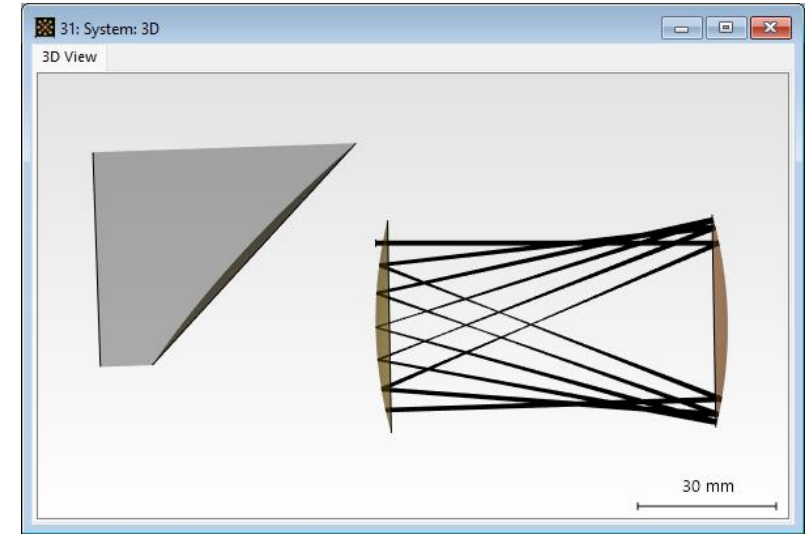
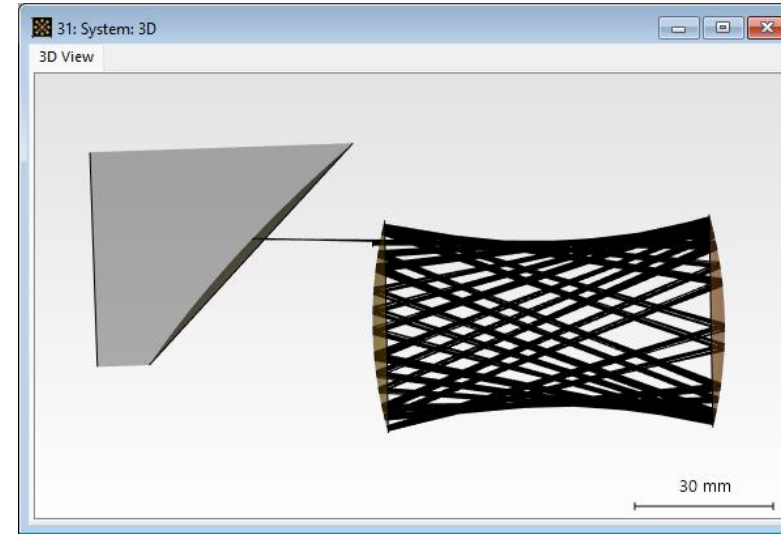
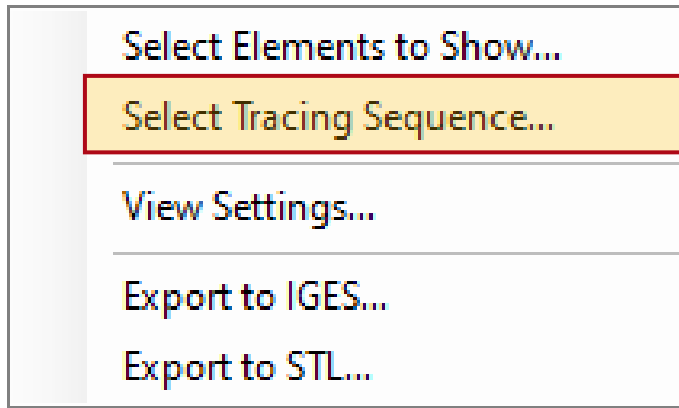

In case of a non-sequential propagation (manual channel configuration) many light paths can be available in the system. The option “*Select Tracing Sequence*” allows the user to select or de-select certain propagation steps for display in the view (by default all light paths are shown).

Options – View Settings

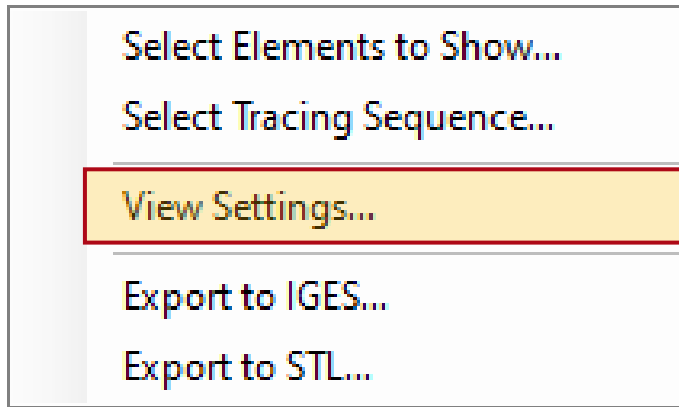

View Settings will open another menu with various options to customize the 3D view, like *Color Scheme*, *View Tools* or depiction style of rays, etc.

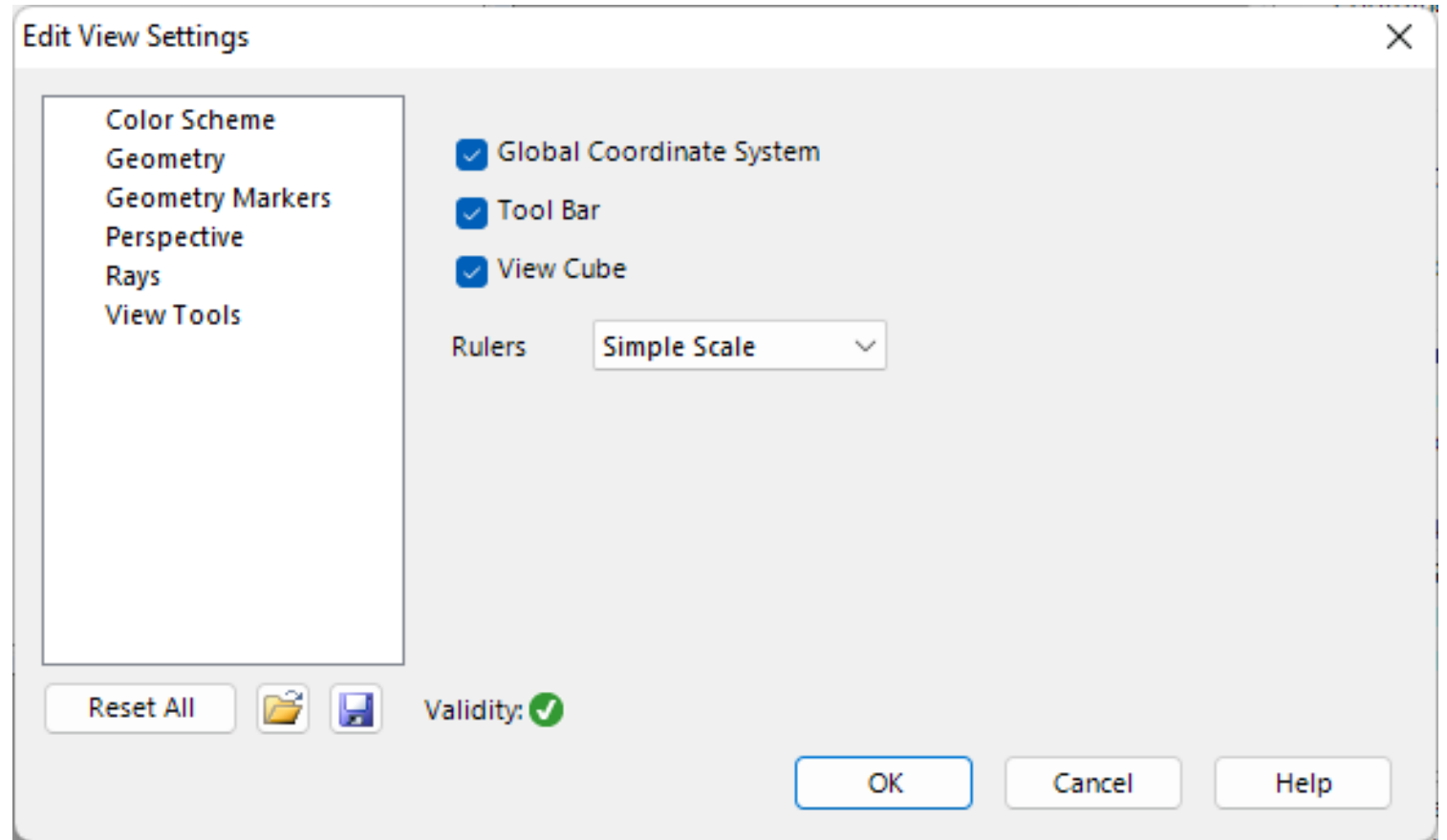

Color Schemes – Background Color

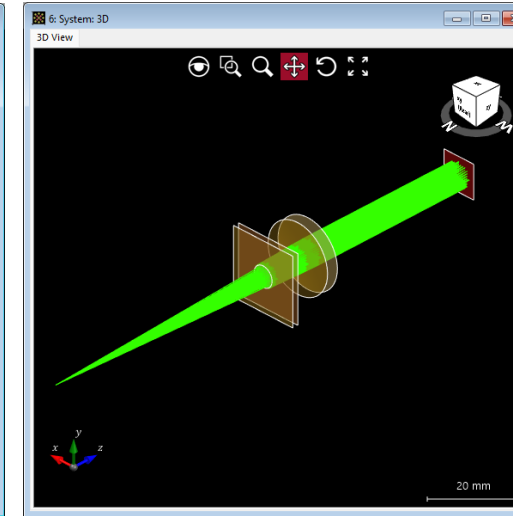
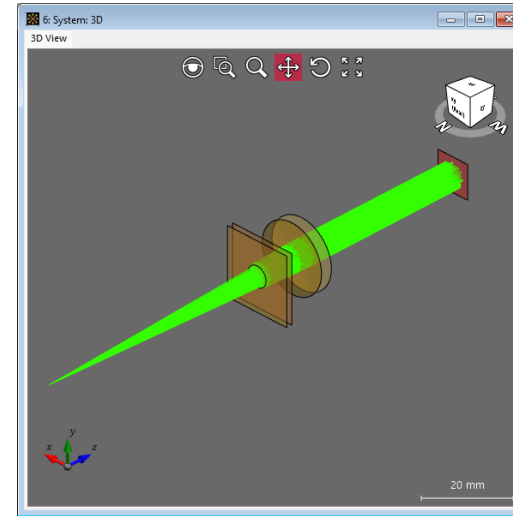
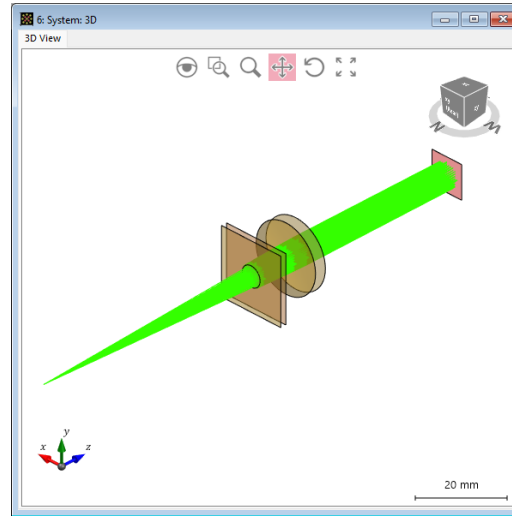
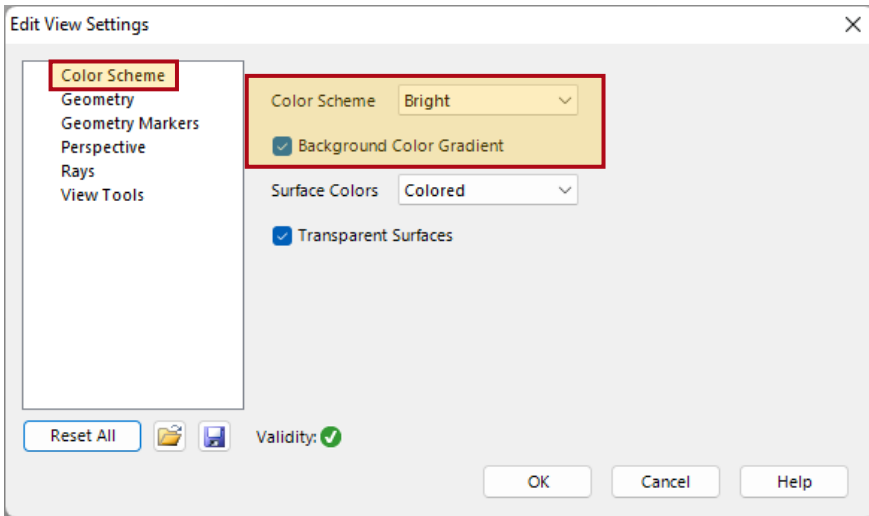

Available color schemes are *Bright*, *Medium* and *Dark*. Furthermore, the user can decide whether to include a *Background Color Gradient* or not.

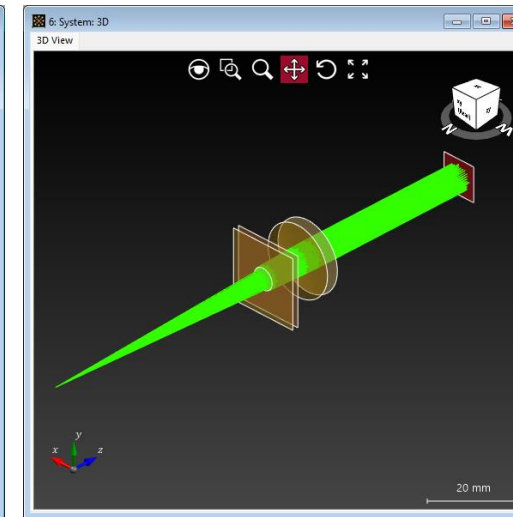
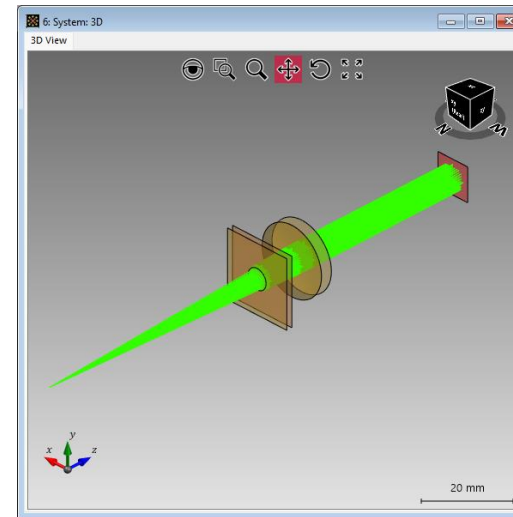
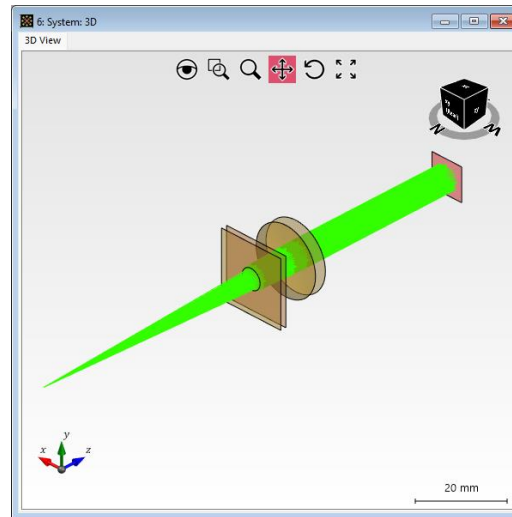

Color Schemes – Components

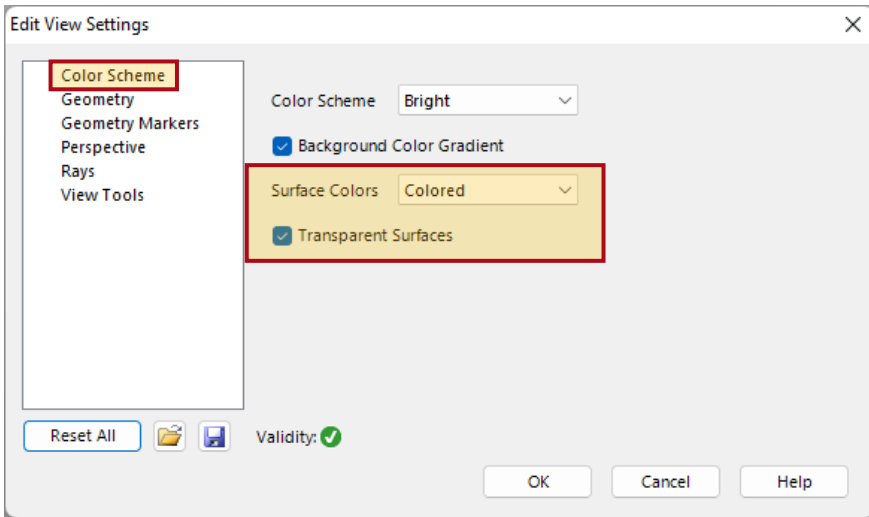

The surfaces of the components can be depicted either *Colored* (green for sources, yellow for components and red for detectors) or *Uncolored*. It is also possible to display them with transparency.

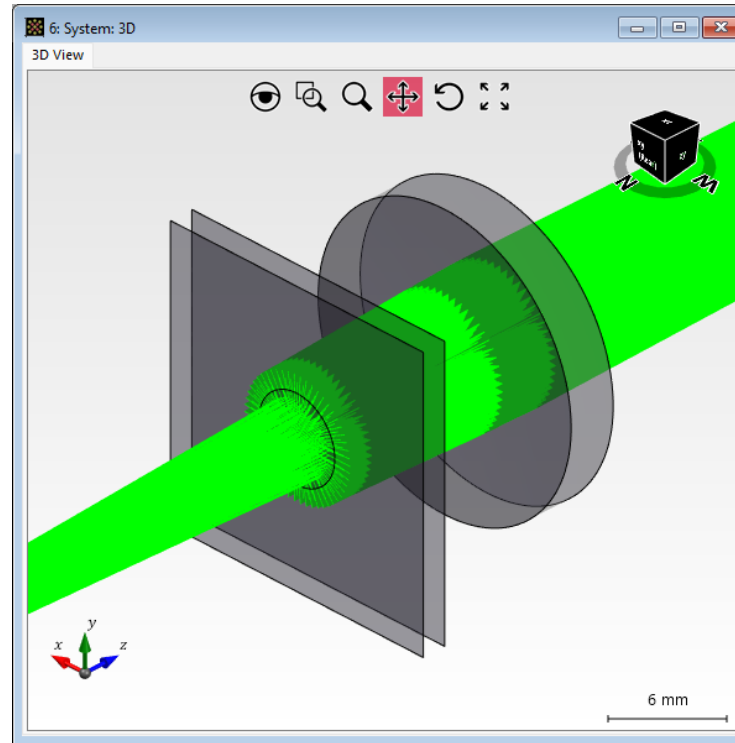

Uncolored surfaces

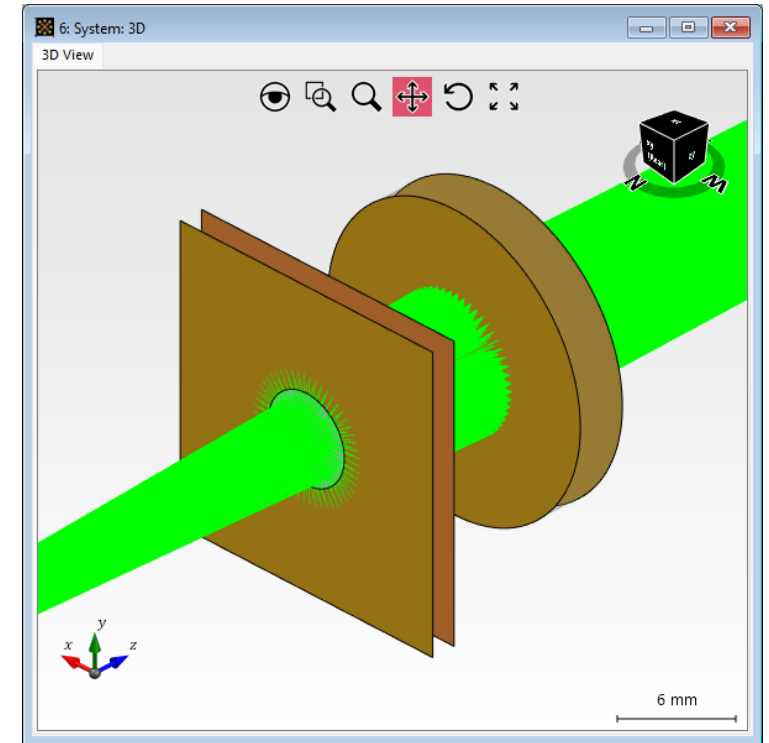

non-transparent surfaces

Geometry – Envelopes

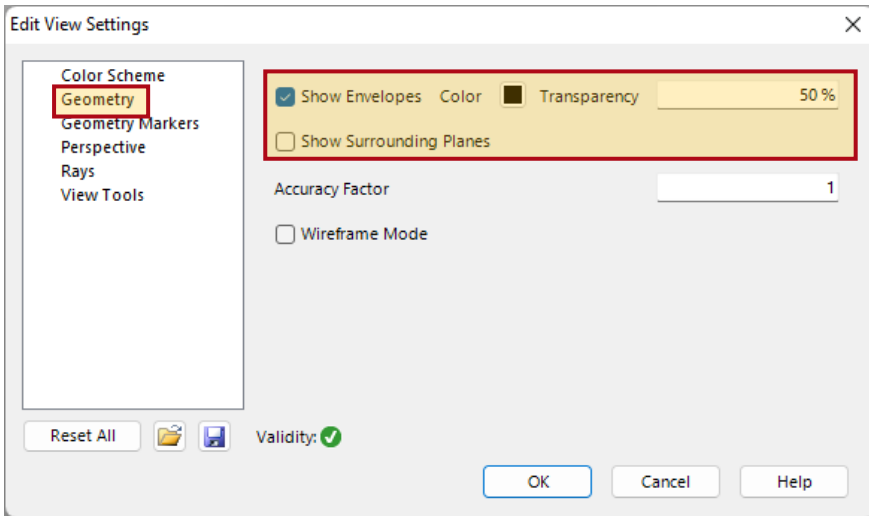

The *Geometry* tab covers the customization of the depiction of system components, such as lens systems. It is possible to show or hide envelopes of the lenses. The envelopes can also be shown with a certain transparency.

with envelopes

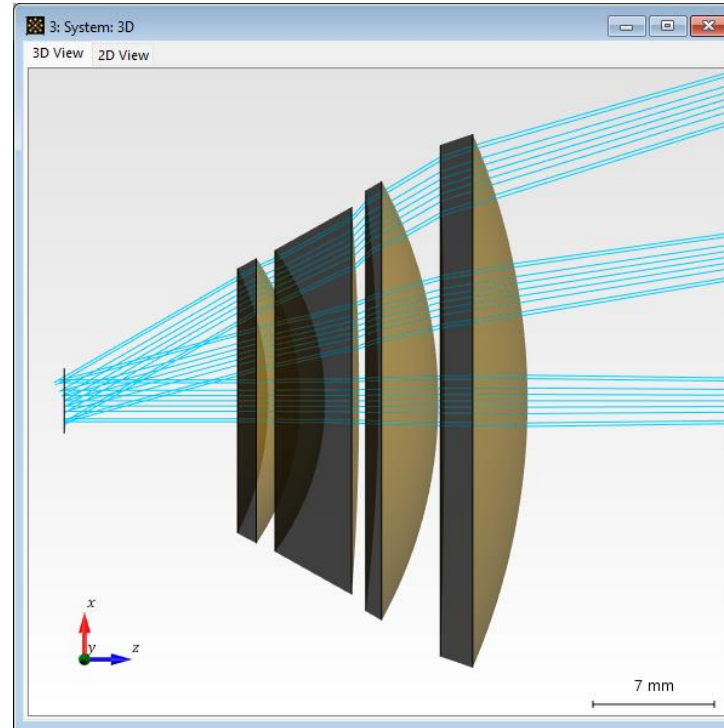

without envelopes

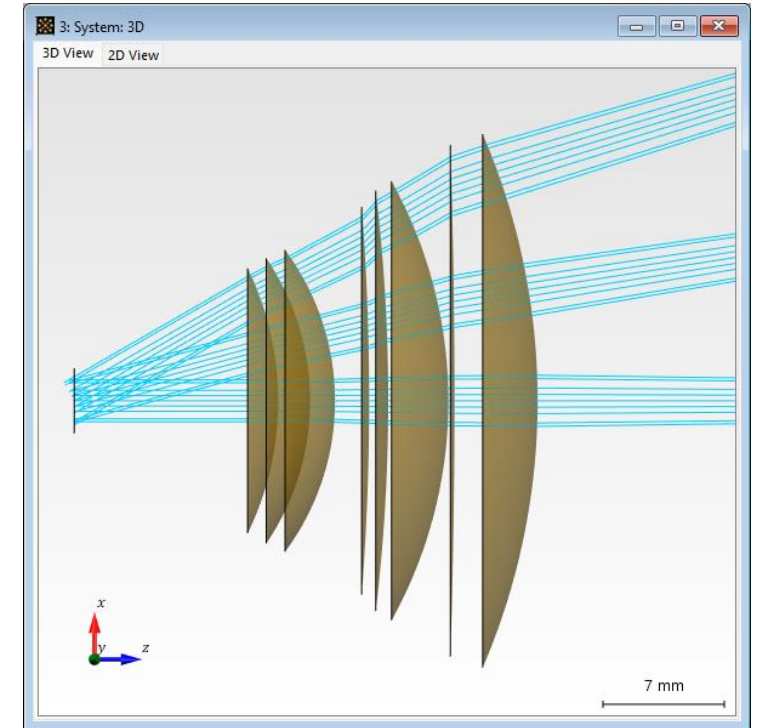

F-Theta Lens - See full use case: [Performance Evaluation of an F-Theta Scanning Lens](#)

Geometry – Accuracy Factor

The *Accuracy Factor* controls the total number of sampling points used to display any surface. An increased *Accuracy Factor* might be helpful for the detailed depiction of structured surfaces or crisp visualization of region borders.

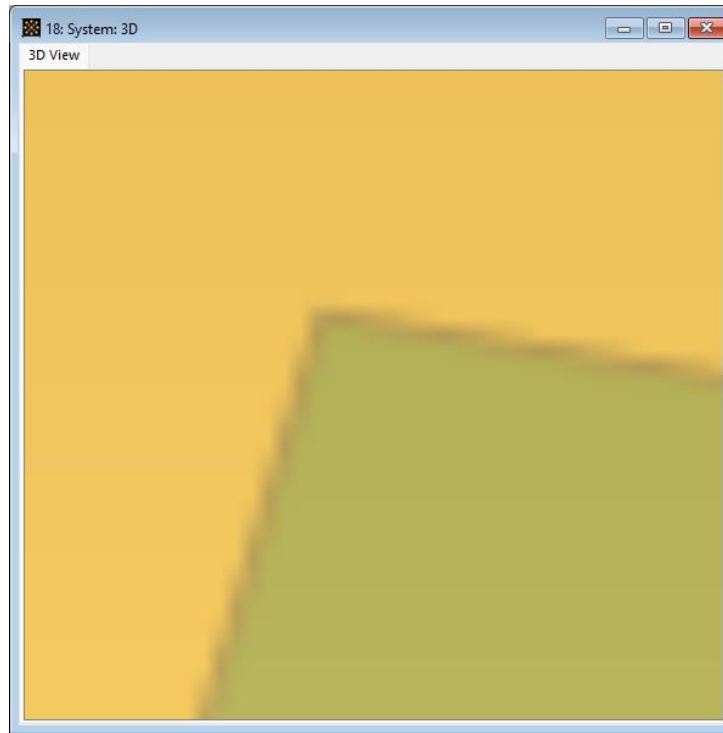
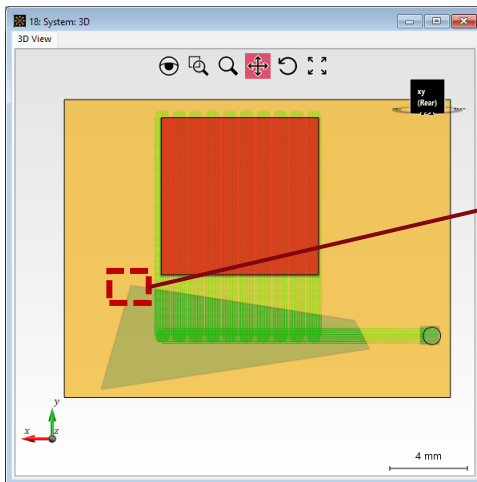
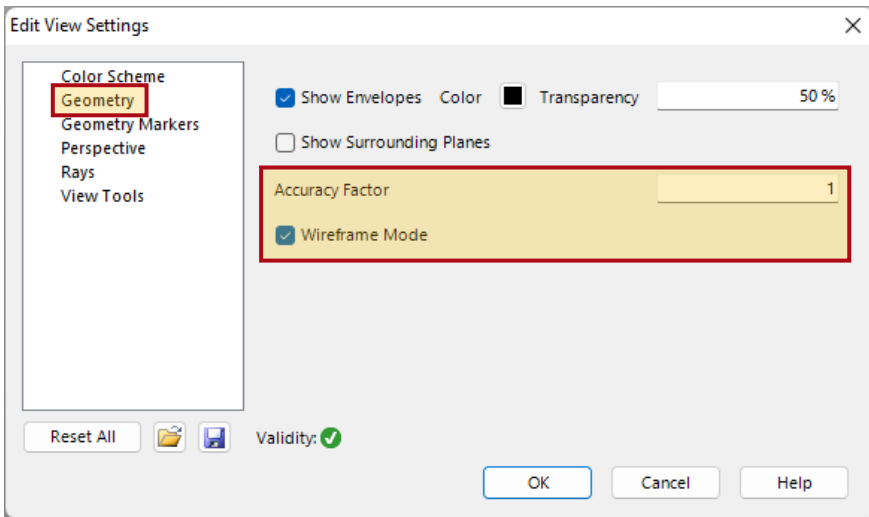

Accuracy Factor: 1

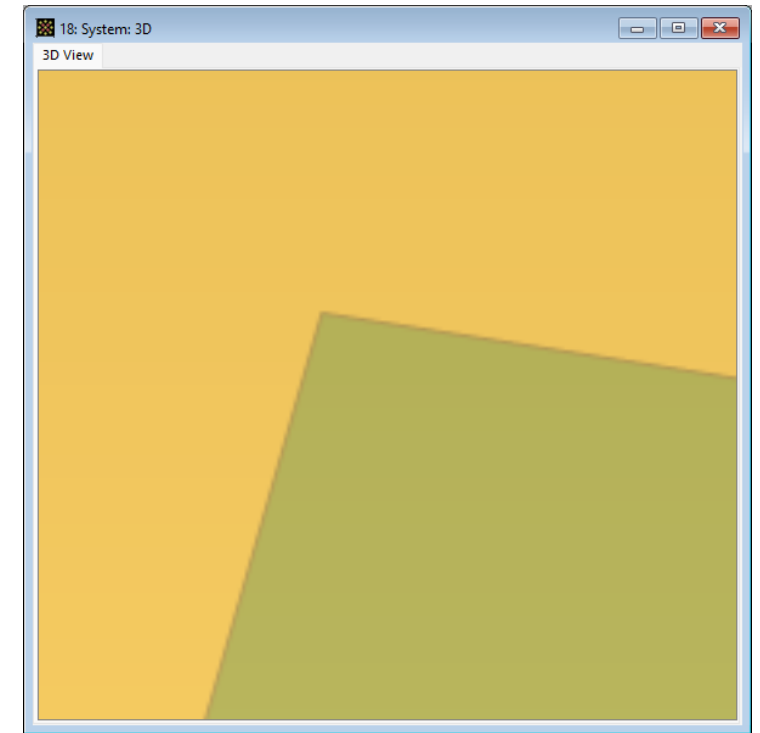

Accuracy Factor: 5

Geometry – Wireframe Mode

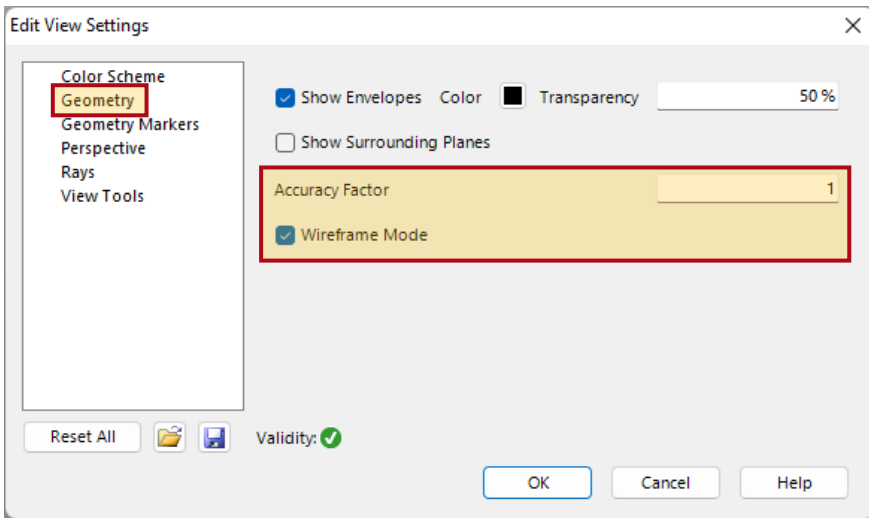

Activating the *Wireframe Mode* will display all surfaces in the system through their mesh. The *Accuracy Factor* will retain the same function in this mode.

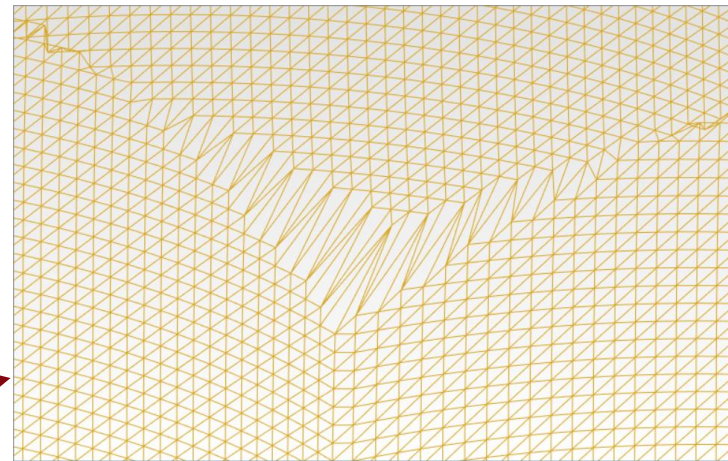
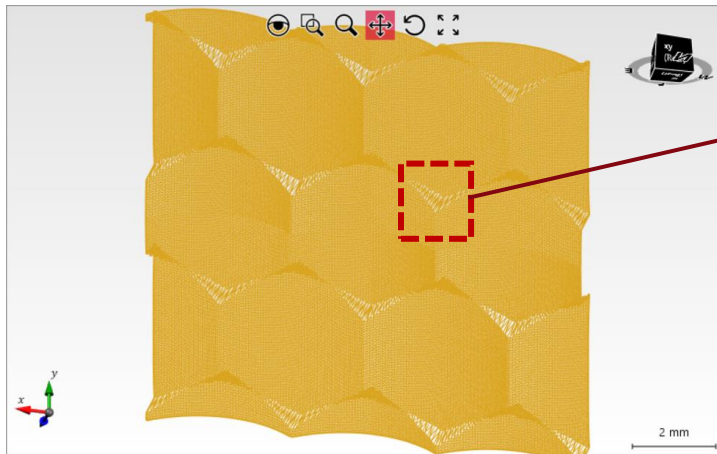

Accuracy Factor: 1

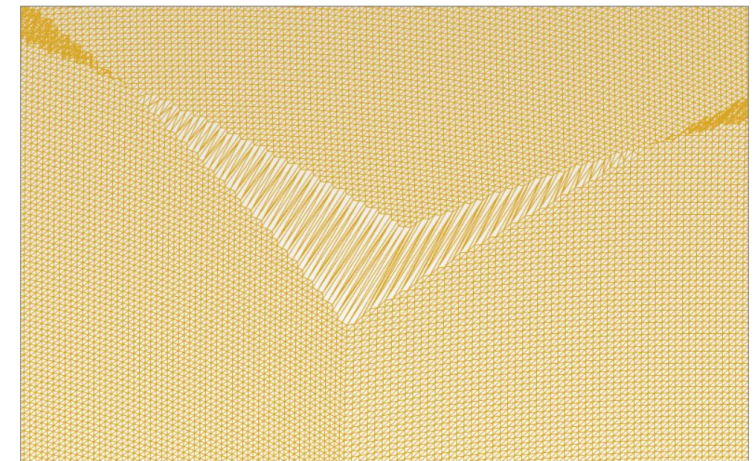

Accuracy Factor: 3

Geometry Markers

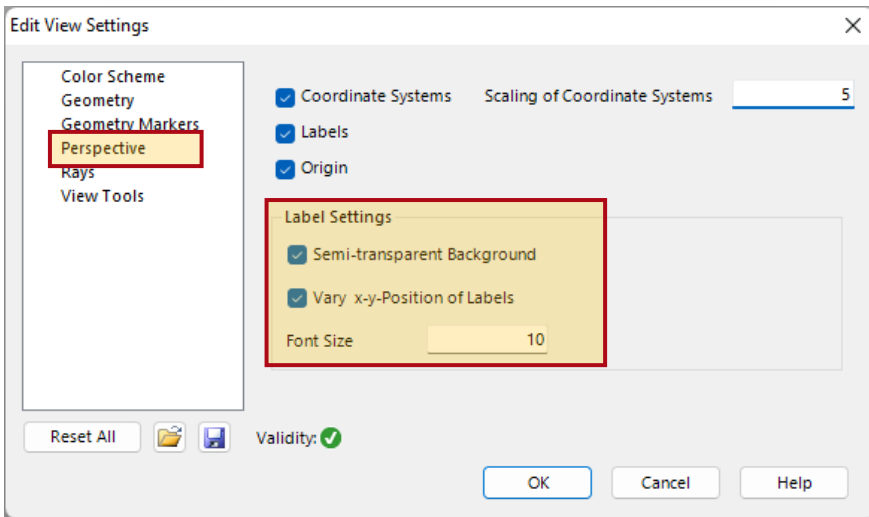

Semi-transparent Background on & off



Vary x-y-Position of Labels on & off

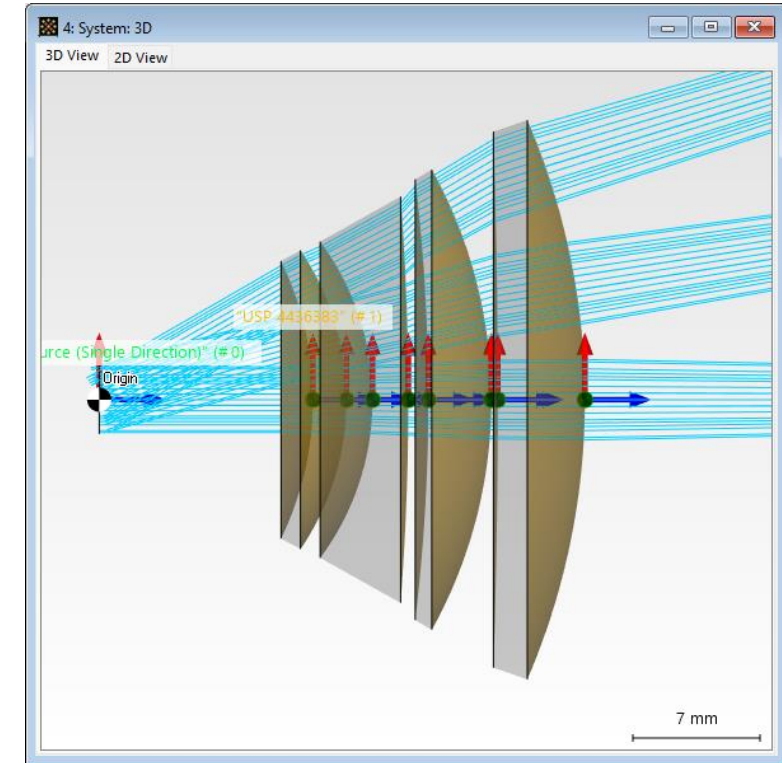
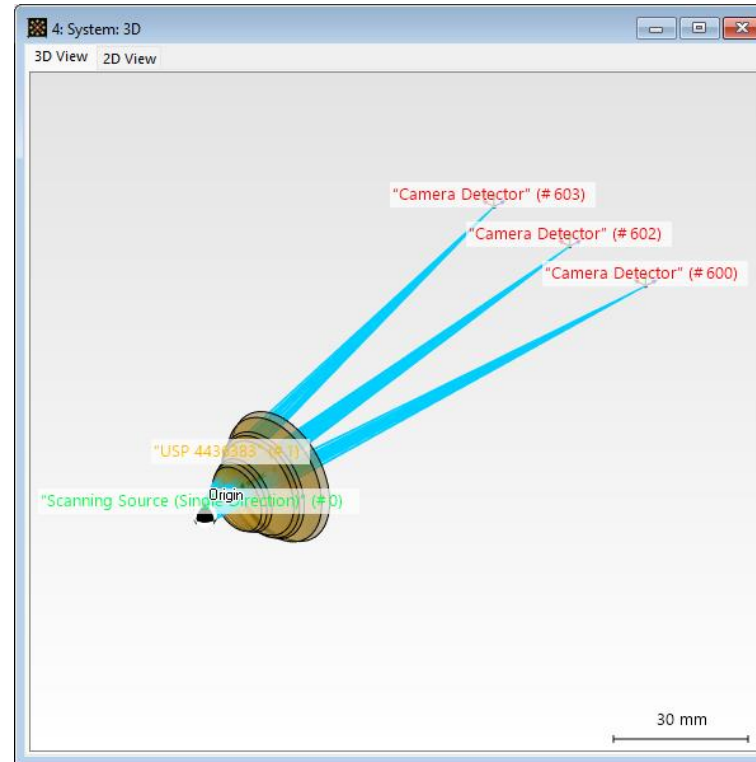
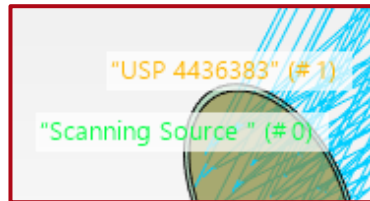
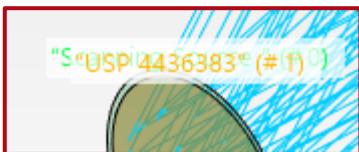

In the *Geometry Markers* sub-menu the display of *Coordinate Systems*, as well as the *Labels* of the elements, can be enabled. In the visualization it is also possible to include the *Origin*, meaning the origin of the global coordinate system (usually the source).

Perspective

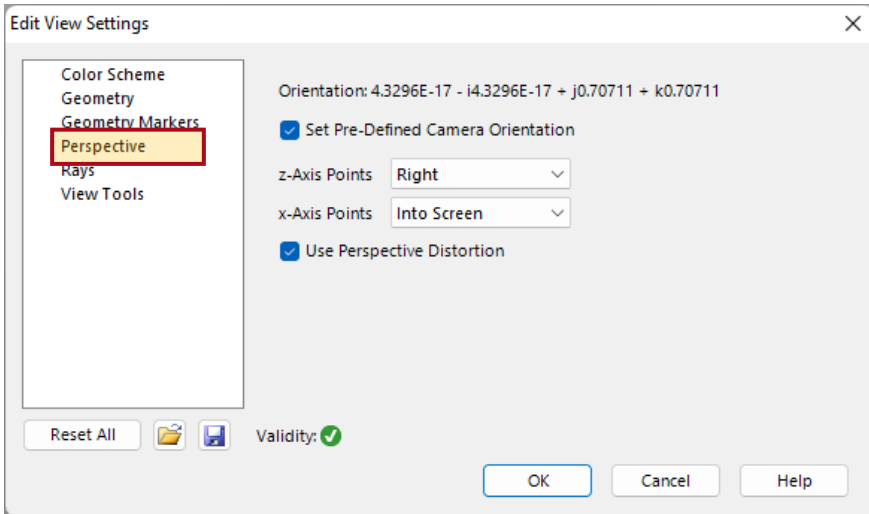

The *Perspective* sub-menu provides options to fix the camera orientation to a desired plane. The current camera orientation is highlighted in the top right corner of the document if the tool *View Cube* is active. Through the parameter *Use Perspective Distortion*, it is possible to highlight certain planes in the optical setup.

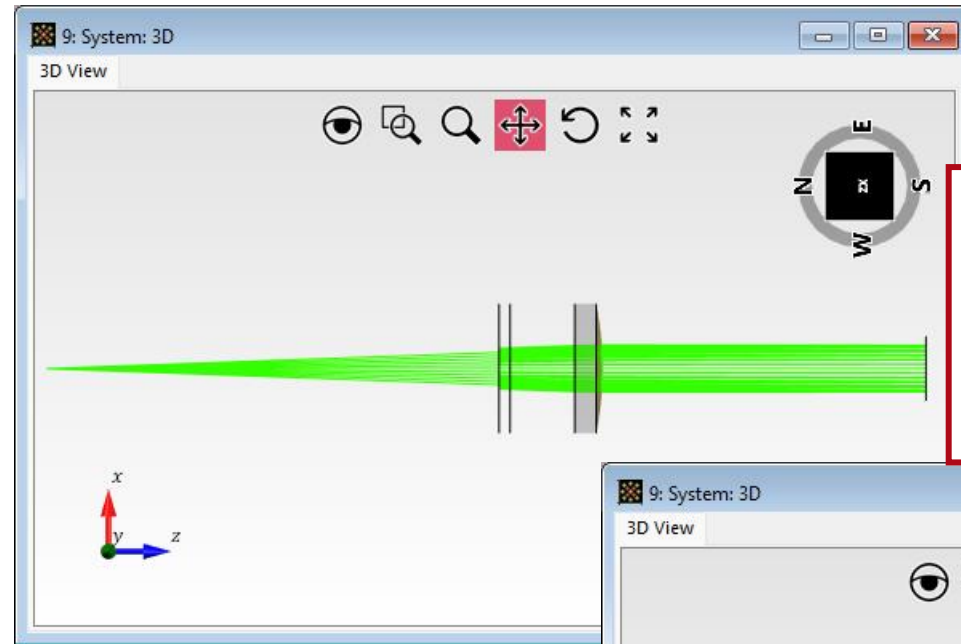

without *Use Perspective Distortion*

Note: While using a pre-defined camera orientation will adjust the view to the specified plane, the user can still rotate the view by using the rotation tool.

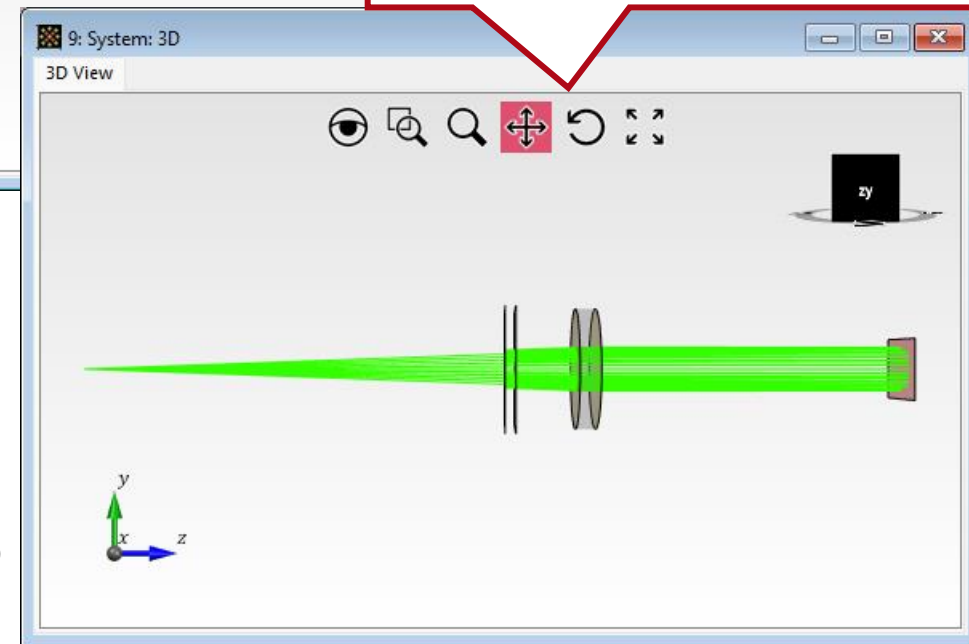

with *Use Perspective Distortion*

Ray Visualization

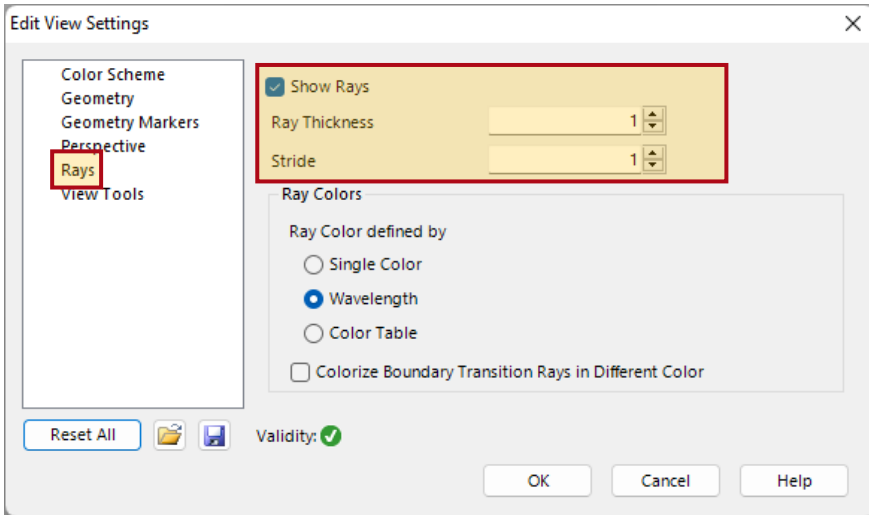

The depiction of rays, including their thickness and gap, can be set in the *Rays* tab of the menu.

ideal transmission grating – 1st order

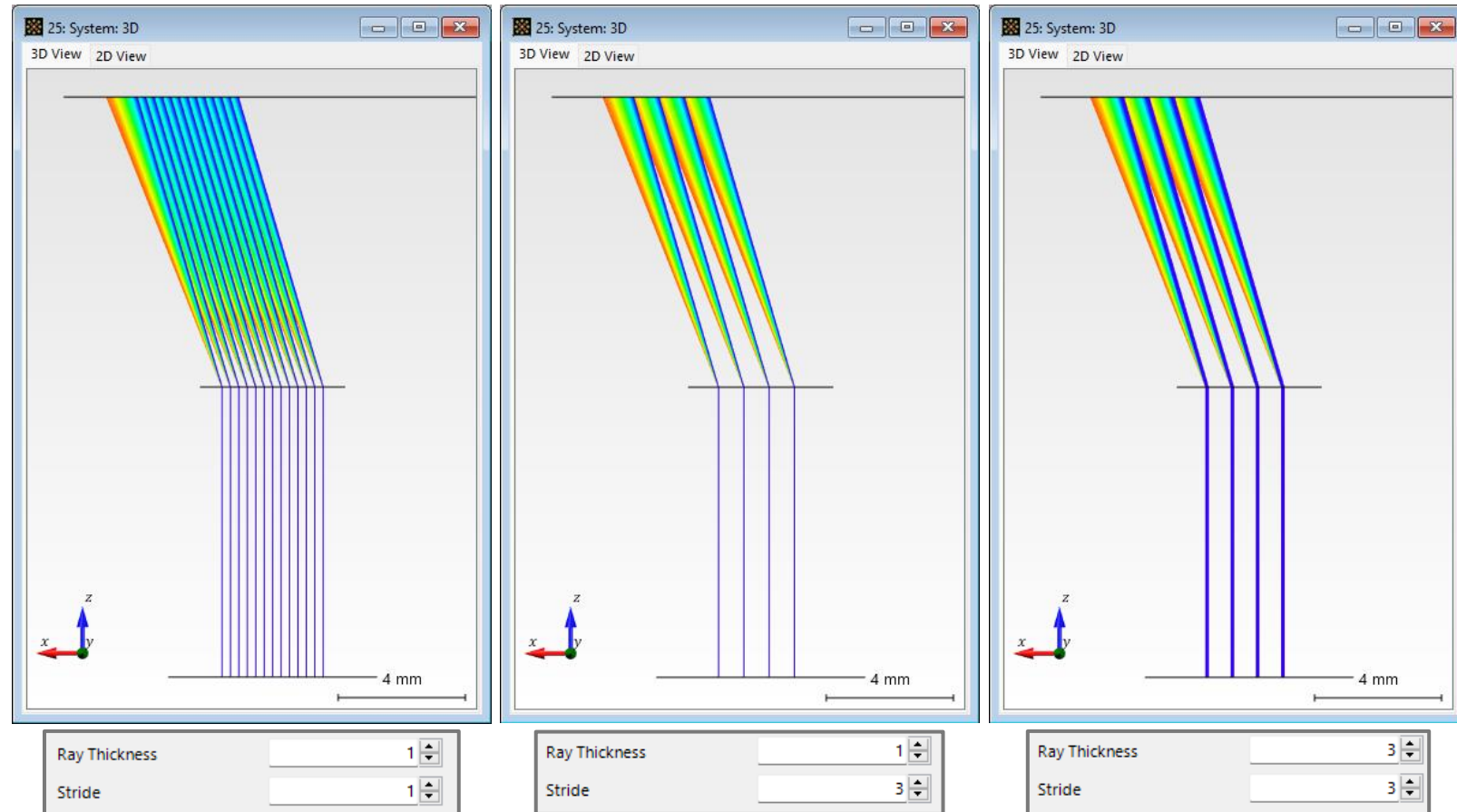

only available for System: 3D (Ray Result Profile)

Ray Visualization for Multiple Wavelengths

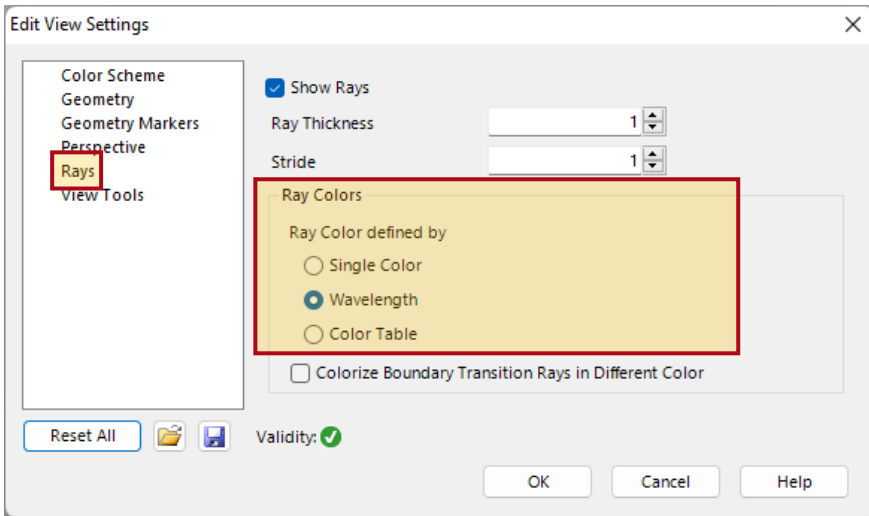

ideal reflection grating doublet – 1st order

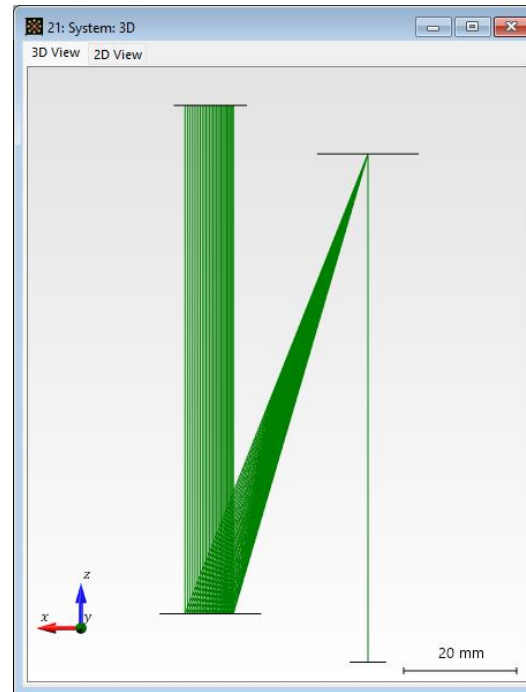

Single Color

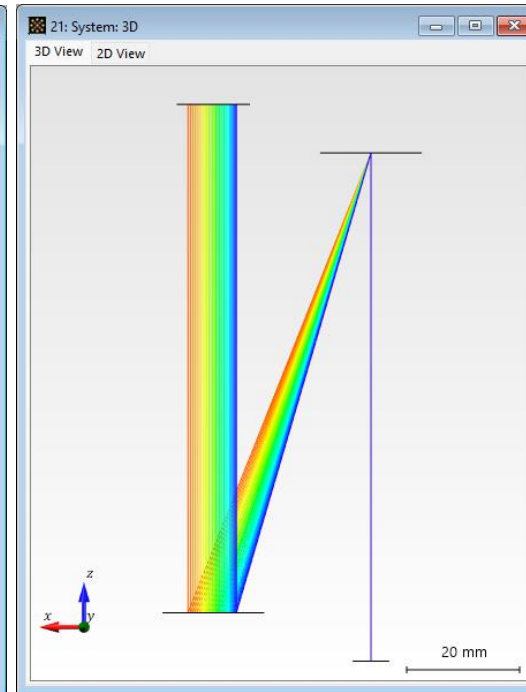

Wavelength

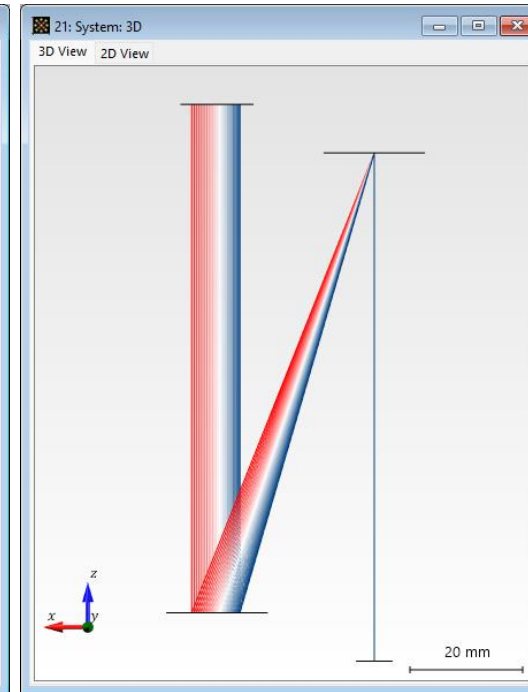

Color Table

For optical systems with multi-wavelength or multi-mode sources, it is also possible to depict the rays according to their specific wavelength or mode by using the real color of the wavelength or a color table.

only available for System: 3D (Ray Result Profile)

View Tools

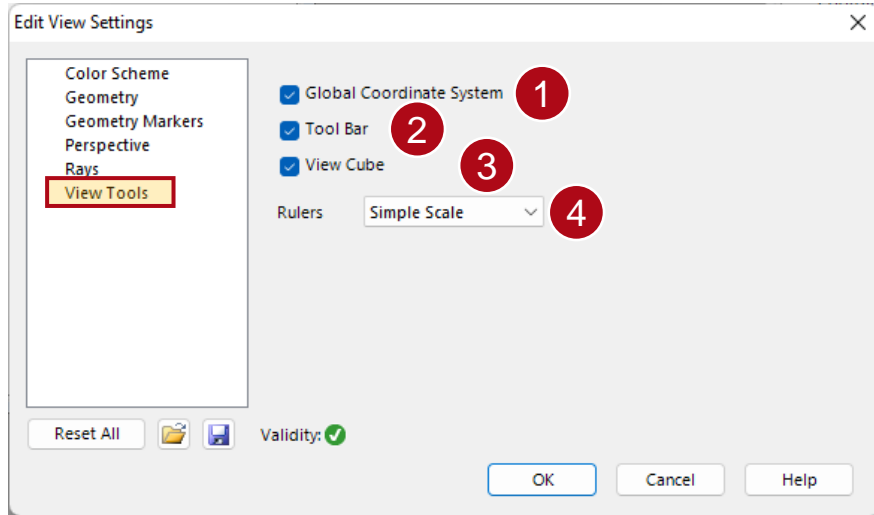

The sub-menu “*View Tools*” provides helpful options to display or omit information in the document window, such as the *Global Coordinate System* (1), the *Tool Bar* (2), the *View Cube* (3) and the *Ruler* (4).

There are also different options to adapt the shown indication of the scale (*Ruler*).

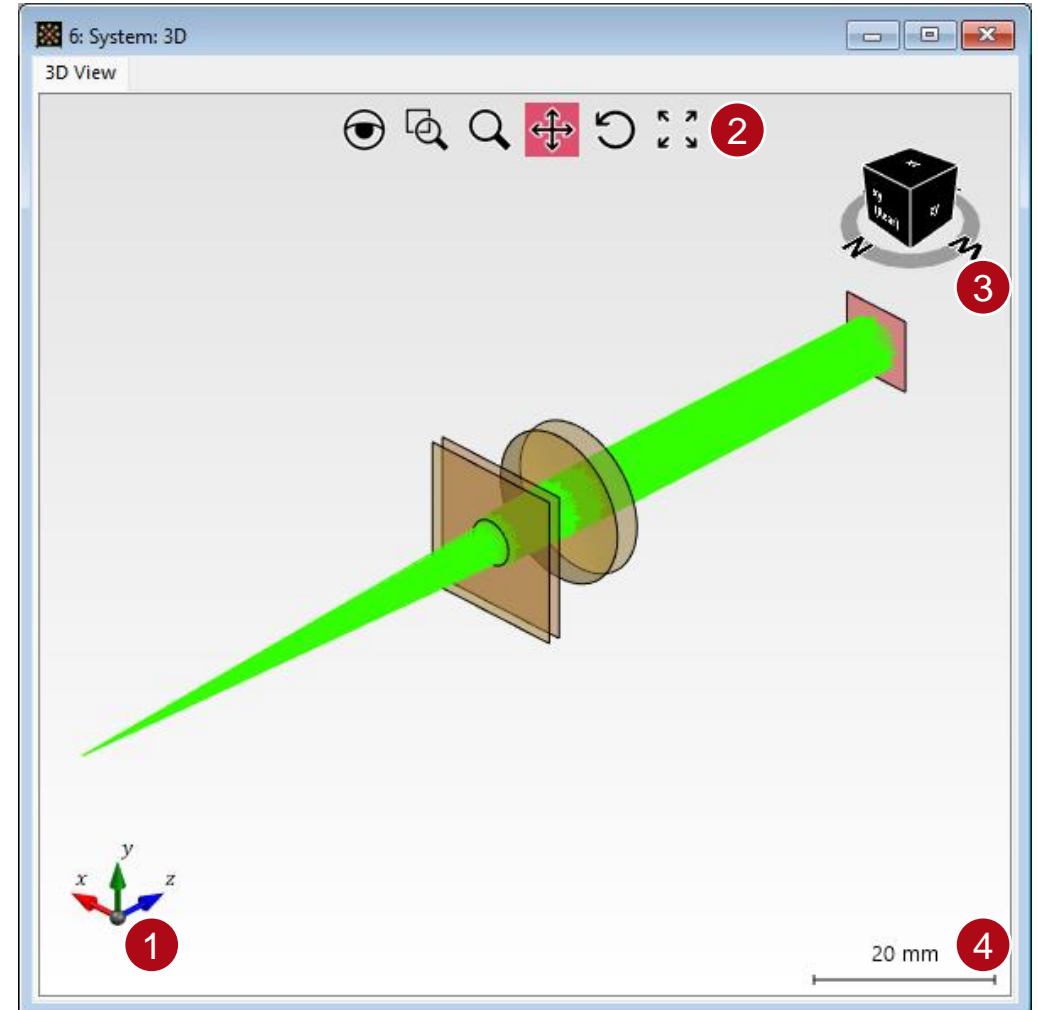
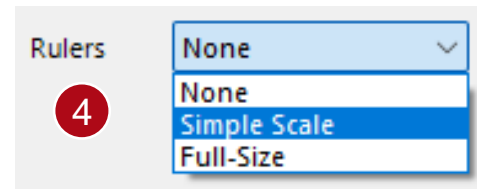

Tips for Positioning

In order to improve the usability, there are a few additional features that we would like to highlight.

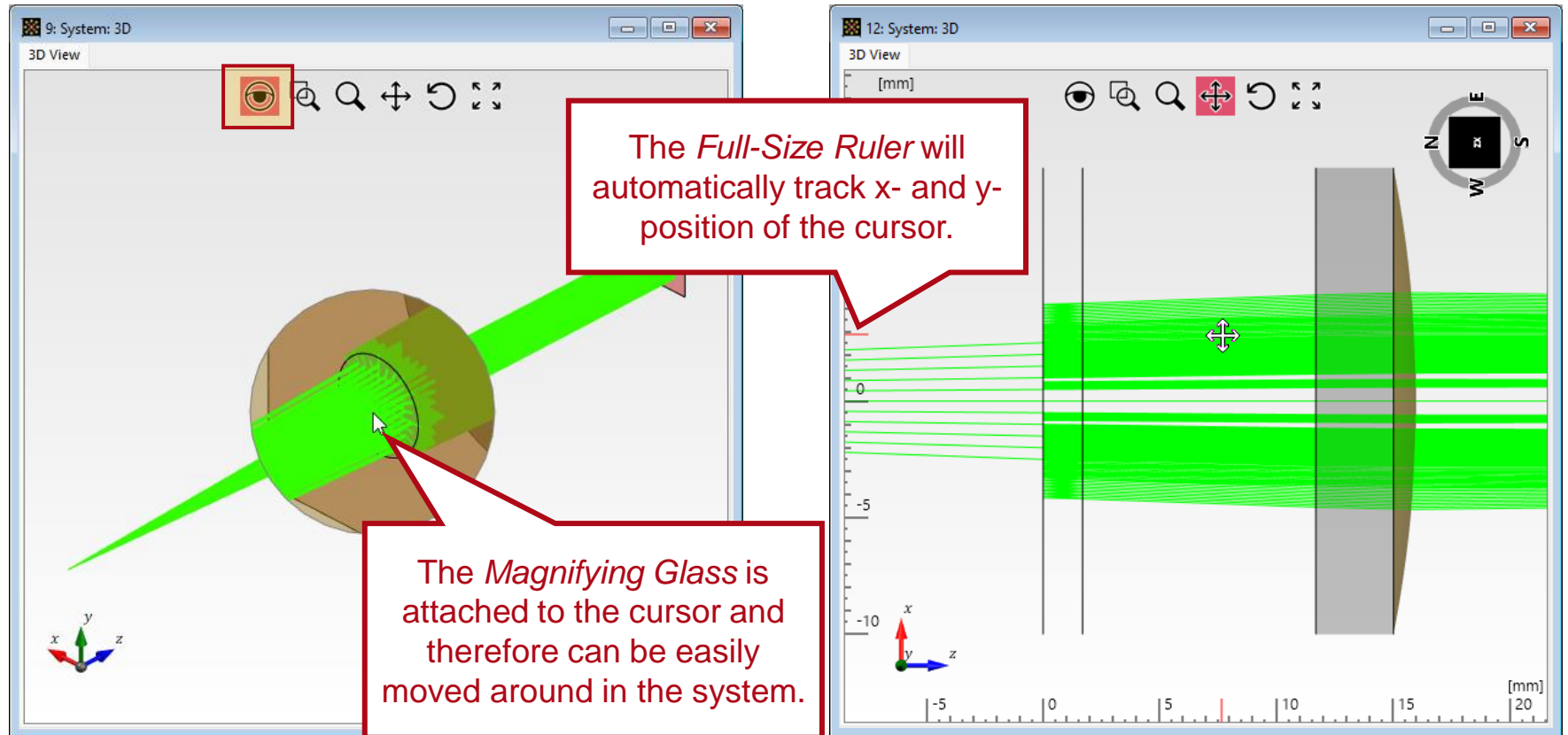

Use the *Magnifying Glass* in the *Tool Bar* to zoom into details without changing the actual system view.

A combination of a *Pre-Defined Camera Orientation* and the *Full-Size Ruler* helps to indicate where light hits a component.

Tips for Fast Access

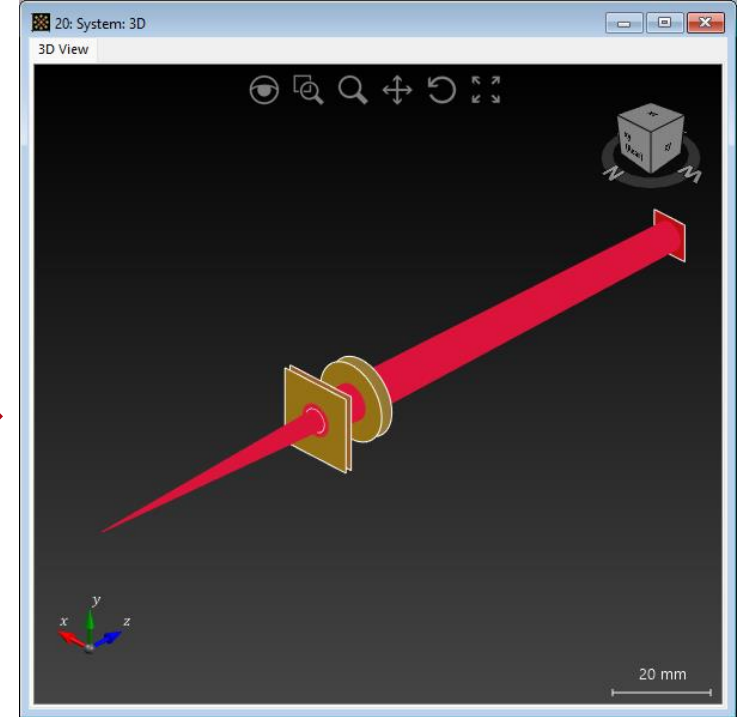
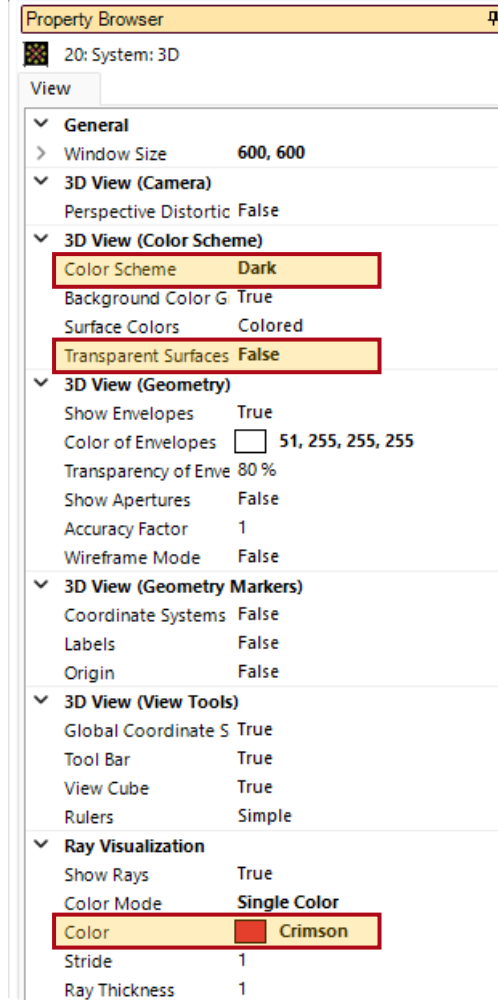
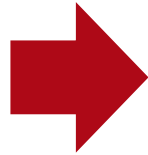
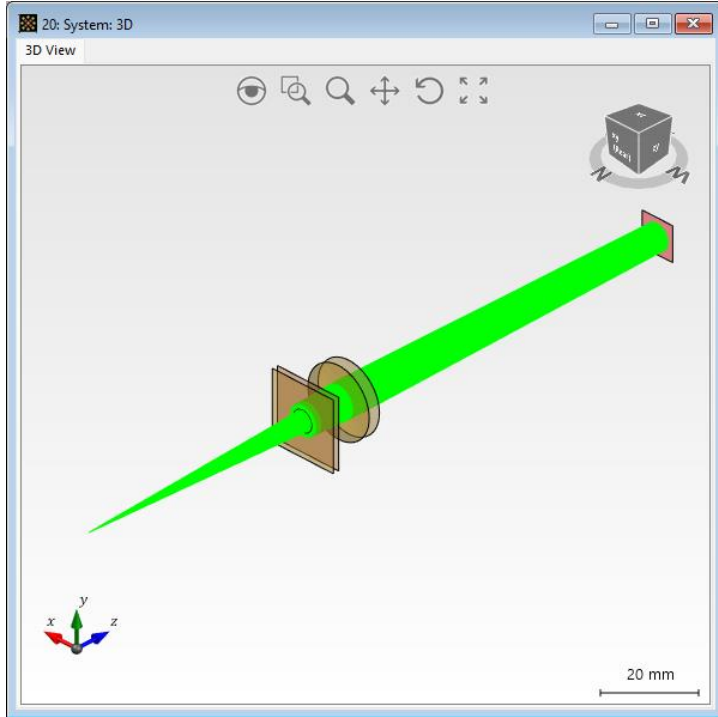

Most options can be quickly accessed in the *Property Browser*.

In the *View* ribbon you will also find tools to quickly copy settings from one document to another.

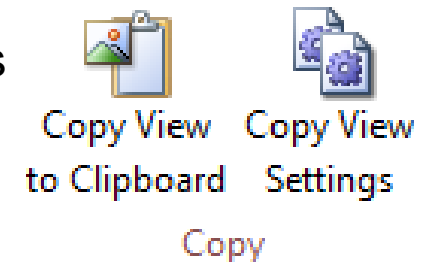

Document Information

title	3D Visualization of Optical Systems
document code	SWF.0015
document version	1.0
software edition	VirtualLab Fusion Basic
software version	2023.1 (Build 1.556)
category	Feature Use Case
further reading	<ul style="list-style-type: none">• <u>Configuring Your Simulation in VirtualLab Fusion</u>• <u>Performance Evaluation of an F-Theta Scanning Lens</u>• <u>Examination of Sodium D Lines with Etalon</u>